

MECHANICAL DRAWING: SILENCER 370 ATX

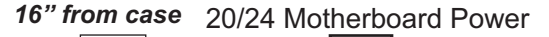

(+3.3V) Orange	1	13	Orange (+3.3V)
(+3.3V) Orange	2	14	Blue (-12V)
(GND) Black	3	15	Black (GND)
(+5V) Red	4	16	Green (PS-ON)
(GND) Black	5	17	Black (GND)
(+5V) Red	6	18	Black (GND)
(GND) Black	7	19	Black (GND)
(PG) Gray	8	20	Not Used
(+5VSB) Violet	9	21	Red (+5V)
(+12V) Yellow	10	22	Red (+5V)
(+12V) Yellow	11	23	Red (+5V)
(+3.3V) Orange	12	24	Black (GND)

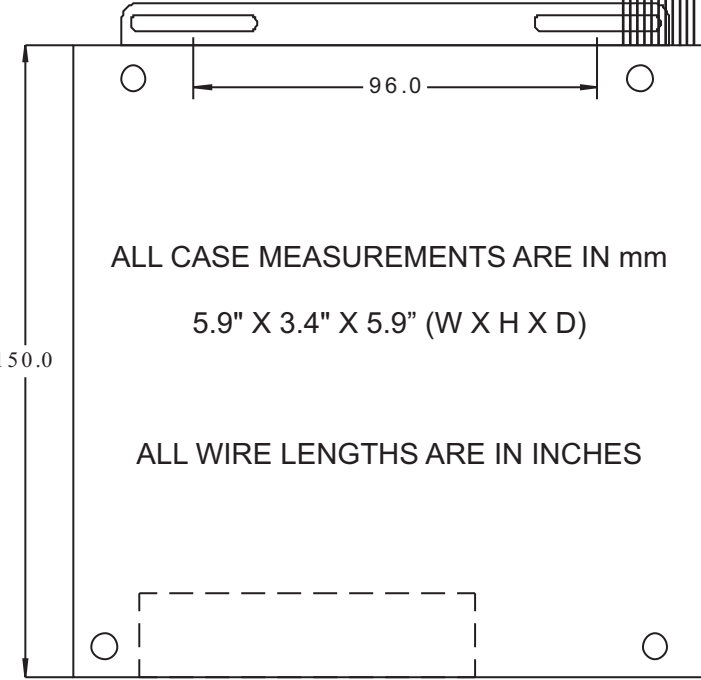
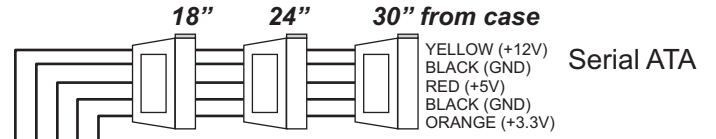
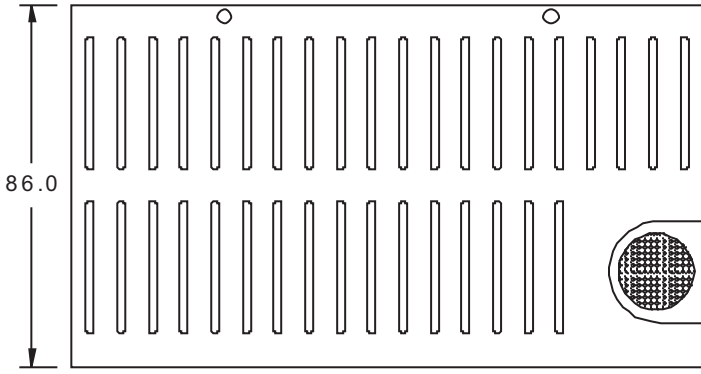
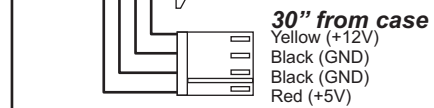
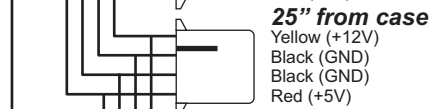
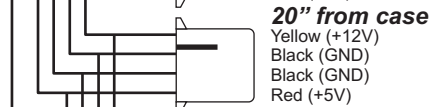
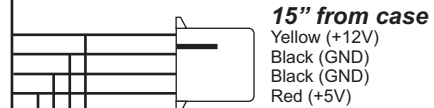
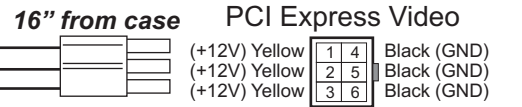
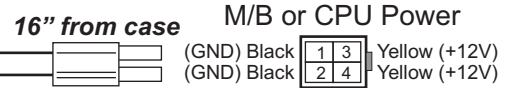

IDE Drive

